

# Reducing Embodied Carbon in Life Science Buildings through Mass Timber

**ONEder Grant Report**

# Table of Contents

## 1 Background

Life Science Buildings, as We Know Them

The Push for Zero Carbon Buildings

## 2 Thesis

Scope of Research and Analysis

## 3 Baseline Analysis

Comparison of Conventional Structural Systems

Embodied Carbon

## 4 Prototypical Life Science Building

Structural Concept

Architecture + Interior

Sustainability

## 5 Conclusion

Summary of Research Efforts

## Bibliography + Acknowledgements



# Background

## Life science buildings, as we know them

### INTRODUCTION

Life science buildings are one of the most important architectural typologies in the post-pandemic world. In these places, scientists work and collaborate to invent life-saving medicine and technology. There is incredible demand for life science space with little to no vacancy in the San Francisco Bay Area market. The demand is due to the growth of start-ups and established firms, which is supported by pharmaceutical R&D investments, VC investments, and NIH funding.

In many markets, life sciences users occupy a significant portion of commercial real estate. In addition to facilities built by end users, developers are constructing buildings and campuses specifically with life science users in mind. Even projects designed primarily for office or research and development are often designed with some considerations for flexibility and adaptability that would allow them to be converted for life science use.

There are several reasons that ordinary office buildings are not well suited for life science laboratories, including larger and more complex air handling systems requiring more outside air, more stringent floor vibration criteria, and larger mechanical and laboratory equipment loads. Life science buildings are more adaptable and efficient when they are planned around a typical 11' laboratory planning module based on the optimum workplace for bench workstations, equipment, and instrumentation along with accessible aisle space allowing for movement. As a result, these buildings often utilize framing bays that are either 22' or 33' wide as the organizing element of the building structure, walls and partitions, as well as distribution of building ventilation, utilities, and services. Traditionally, steel or concrete structures are the go-to construction systems to meet the more stringent requirements mentioned above. These carbon-intensive systems amplify the environmental impact from the operation of life science buildings, which generally consume more energy and resources than other commercial office buildings.

### THE PUSH FOR ZERO CARBON BUILDINGS

The Intergovernmental Panel on Climate Change's special report presented the impacts of global warming of 1.5 °C above pre-industrial levels and the urgency for action to bring the emissions down to zero by mid-century. The built environment sector has a vital role to play in responding to this climate emergency as buildings are currently responsible for 39% of global carbon emissions. Decarbonizing this sector is one of the most cost-effective ways to stay within the limited remaining carbon budget and mitigate the worst effects of climate change.

In looking at the total carbon emissions from the built environment, embodied carbon emissions contribute around 11% of all global carbon emissions. Though these have largely been overlooked historically, Architecture 2030 estimates that 80% of the total greenhouse gas emissions for new buildings will come from embodied emissions. While we must continue to focus on addressing operational carbon, we must also rapidly increase efforts to tackle embodied carbon emissions to avoid catastrophic climate breakdown.

For new buildings, the structural systems including foundations, frames, and superstructure often represent the biggest contribution to embodied carbon as these contain large volumes of carbon intensive load bearing materials such as concrete and steel. Globally, portland cement and steel are two of the largest sources of material-related emissions in construction due to their energy intensive emissions process and the release of CO<sub>2</sub> during manufacturing.

Mass timber is a beneficial alternative to steel and concrete because its manufacturing and transportation emit less carbon than concrete and steel. Also, timber products present possibilities for capturing and storing carbon sequestered during growth, also known as biogenic carbon.

When trees grow, they take up CO<sub>2</sub> and water into the wood until decomposition when the CO<sub>2</sub> is returned to the atmosphere. However, the treatment of timber at end-of-life can have a significant effect on its embodied carbon. At the moment, the most likely end-of-life scenario for wood product waste handling is incineration, in which case the stored carbon is released back into the atmosphere. A circular economy approach for timber, which means consideration at the design stage of how timber products can be repurposed following initial use, can further extend the time over which the biogenic carbon stays out of the atmosphere.



A typical steel and concrete life science building

# Thesis

- + We present an innovative approach to a timber structure design, fully integrated with building systems and functions that can provide a viable alternative to current steel and concrete systems.
- + Comparing this approach to typical current design practice, we demonstrate that this approach can result in a significant reduction in the carbon footprint
- + We identify areas of further research and tools needed to apply this type of innovation to real-world projects

## WHAT IS THIS RESEARCH ABOUT?

We are studying ways to assemble a mass timber building to use materials more efficiently and integrate mechanical and other systems typically required in life science buildings, with the goal of making the environmental benefits of mass timber more attractive to life science developers and end users.

Mass timber has recently gained significant attention as a building material for larger projects. The development of the cross-laminated timber (CLT) panel has opened up new design possibilities, and because timber is a renewable resource that sequesters carbon, from an environmental standpoint it is seen as a highly desirable alternative to steel and concrete construction.

This technology, however, is still in its infancy in many ways. While some building code provisions and standards have been adopted over the last few years, few are proscriptive and many require detailed analysis and knowledge of varying manufactured products. Additionally, most architects, engineers, and builders are not familiar with CLT panel construction. Developers and end users understandably have doubts as to its cost and performance.



Mass timber building with expressed timber elements

Buildings designed to accommodate life science laboratories have specific requirements, creating additional barriers to the adoption of mass timber as a primary structural material:

### + Stringent vibration criteria

Laboratory users typically demand more stringent vibration criteria. Simplified procedures for assessing vibration performance early in the design process are very limited, making it difficult for design engineers to assure clients that a timber building will provide performance equivalent to a steel or concrete structure.

### + Shorter spans, bigger beams

For a typical post and beam system, meeting enhanced vibration criteria requires significantly shorter spans and/or larger beams. More columns and lower clear heights to structure make the spaces less attractive to potential life science users. Taller floor-to-floor heights and massive beams add to construction costs.

### + Higher floor-to-floor

HVAC systems require larger distribution ducts, driving greater floor-to-floor height and construction cost.

# Thesis

Given these realities, the adoption of mass timber construction for life science buildings faces serious headwinds, particularly in the developer sector. To make mass timber a competitive—and attractive—alternative, we believe a re-thinking of how mass timber is utilized in the structure will be required. This will require developing systems that make more efficient use of materials and are integrated with mechanical systems.

In reimagining the building structure, we saw two big opportunities to make mass timber a more efficient and better performing alternative to steel and concrete structures.

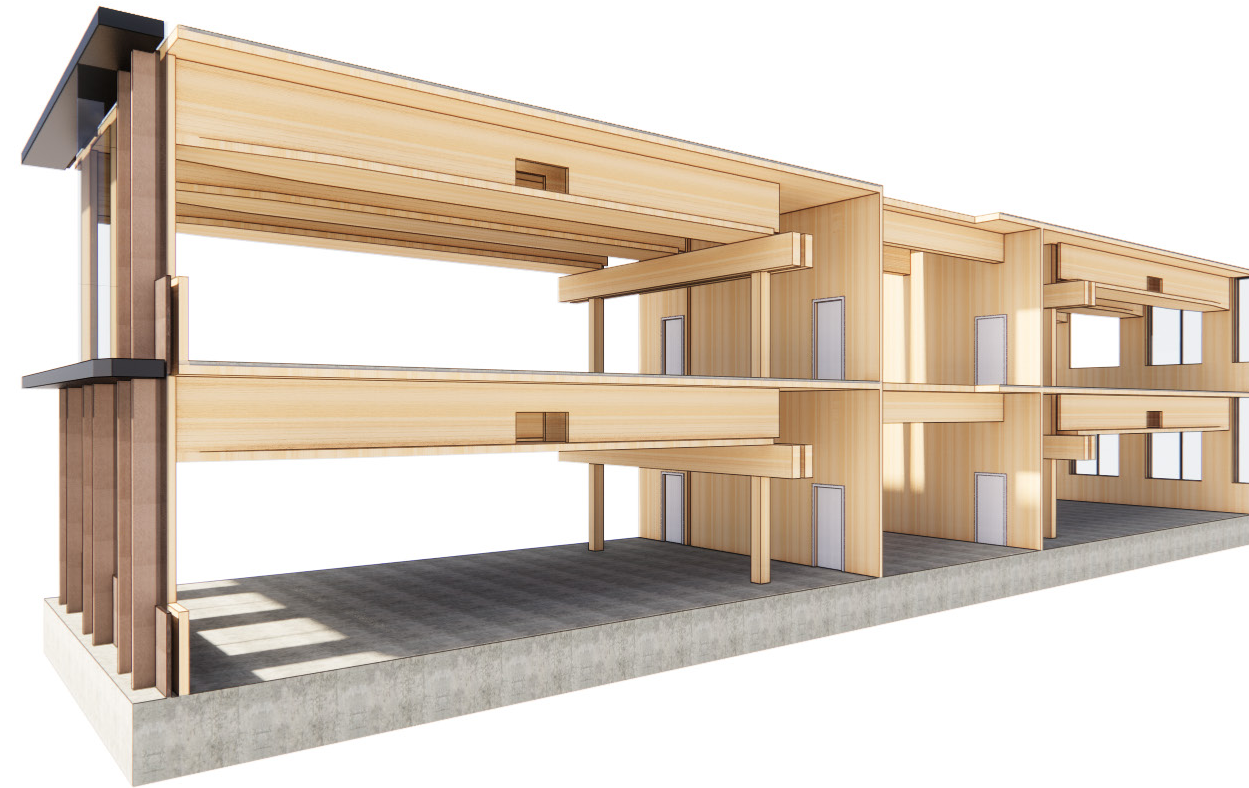

First, creating long span, high-performance floors with mass timber has generally meant very deep, massive beams. As an alternative, we explored ways of assembling CLT panels into I-shaped sections that significantly increase the efficiency of material use and provide a much stiffer floor section.

Second, we looked at how these components could be assembled into a floor system that integrated the larger mechanical and distribution systems that life science buildings typically require. Because CLT panels can span in both directions, creating clear paths for ducts and utilities directly below the floor plate is possible, greatly reducing the interstitial depth and floor-to-floor height required.

To make sure that this re-thinking could provide tangible and applicable benefits, we created baseline floor framing models for steel, concrete, conventional mass timber, and CLT/steel hybrid systems with similar bay sizes and target vibration performance. These models allowed us to make apples-to-apples comparisons of material quantities and embodied carbon.

While our research focused primarily on the floor system, we also felt we needed to demonstrate how our proposed system would work in a complete, realistic life science building. To that end, we created a complete building model and test fit to illustrate how the system can work with laboratory benches and equipment, distribution systems, and other typical life science program requirements.

# Baseline Analysis

## Structure

Regardless of the material, the design of long-span floors is often governed by the control of vibration rather than strength. This is doubly true for life science buildings, where floors must be able to accommodate microscopes and other sensitive equipment. To verify that our proposed approach could provide vibration performance better or equal to currently employed systems, we created a series of baseline framing bays in different materials to compare the vibration performance. These models were also used for takeoffs to directly compare material use and net carbon footprint.

To make the comparisons as meaningful as possible, we designed typical floor bays of 22' by 44' for each material. Quantities were based on a typical 3-bay building section. Each was designed for a 125 psf live load and targeted an 8000 mips vibration performance when assessed for a moderate pace (75 steps/minute) walking load. These parameters were chosen to be similar to those currently used for the design of new life science buildings in the San Francisco Bay Area.

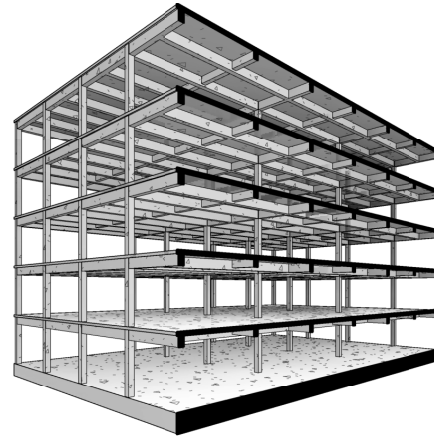

### CONCRETE

- + 8" ordinary reinforced concrete slab
- + 16"x28" deep beams at 11'-0" stiffened at midspan
- + 16"x28" deep girders
- + 24"x24" columns



### HYBRID STEEL/CLT

- + 2" normal-weight concrete topping
- + acoustic mat over 5-ply CLT panel
- + W27x84 beams at 11'-0"
- + W27x84 girders
- + W14x99 columns



### STEEL

- + 5-1/4" light-weight concrete over 2" metal deck
- + W24x68 beams at 11'-0"
- + W24x76 girders
- + W14x99 columns



### MASS TIMBER

- + 2" normal-weight concrete topping
- + acoustic mat over 5-ply CLT panel
- + 12-1/4" x 43-1/2" beams at 11'-0"
- + 12-1/4" x 43-1/2" girders
- + 12-1/4" x 12" columns

# Baseline Analysis

Designing a consistent vibration criterion proved to be a significant challenge. While detailed vibration analysis procedures exist for each material, there is a wide variation in their methodologies. Much of the input needed to perform these analyses would not be known for a prototype building. Assumptions can be made, but they are difficult to apply consistently.

Design for the vibration of timber structures is still very much in development. The methodology presented in the "U.S. Mass Timber Floor Vibration Design Guide" requires finite element modeling of multiple floor bays and detailed post processing. While it is practical to implement this analysis in an actual building design, it proved to be too unwieldy and assumption-laden for this study. Simplified procedures do exist, but they apply only to simple span, bearing wall systems.

To be reasonably sure that the timber baseline designs and our prototype can provide similar vibration performance, we adopted the methodology presented in Chapter 6 of the first edition of AISC Design Guide 11, "Floor Vibrations due to Human Activity". This analysis procedure estimates vibration directly from the stiffness and frequency of the floor, which is easily derived from analysis models.

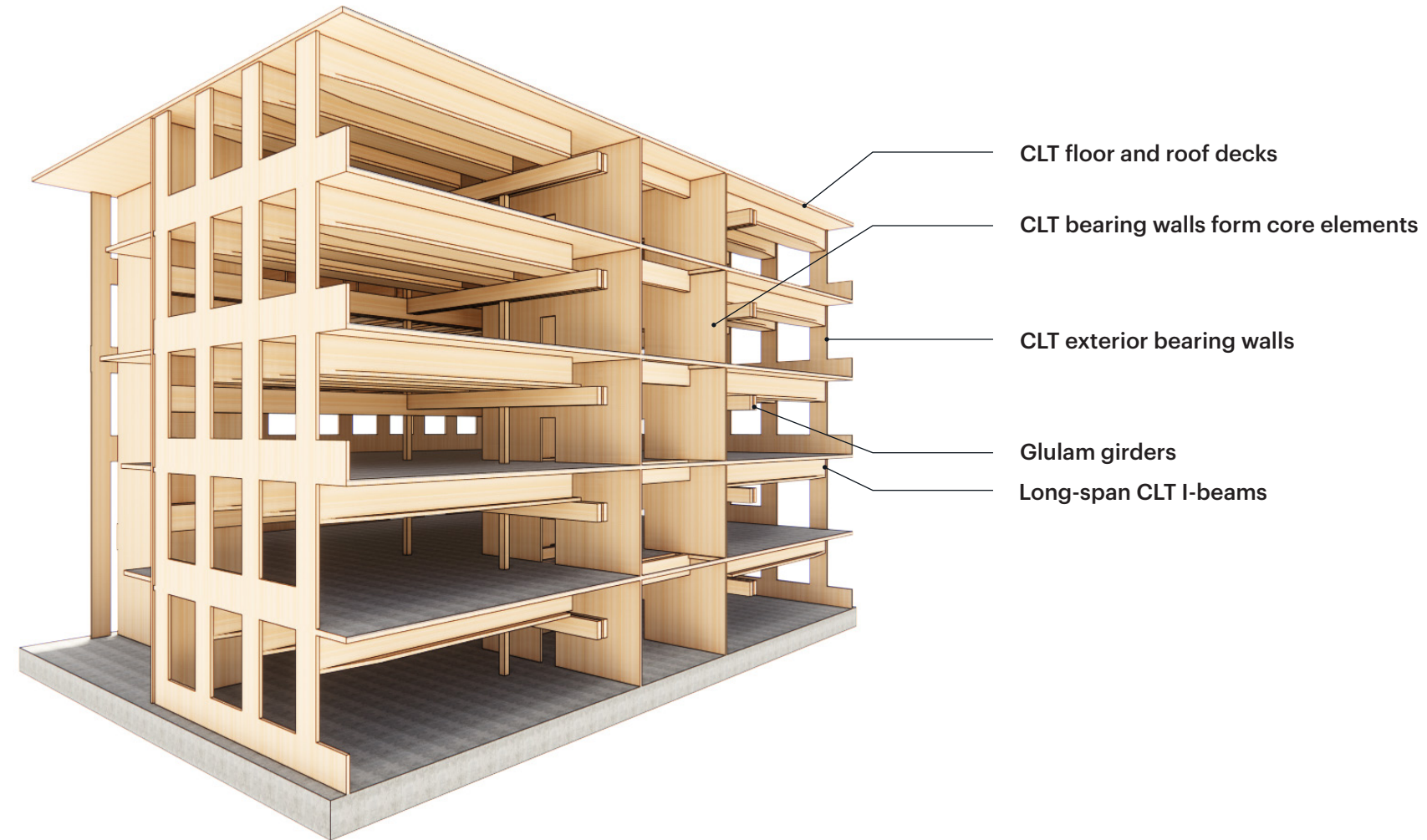

**PROPOSED MASS TIMBER**

# Baseline Analysis

## Embodied Carbon

Embodied carbon refers to emissions associated with materials and construction processes throughout the whole lifecycle of a building or infrastructure. This includes Product and Construction stage emissions (A1 through A5) including material extraction, transport to manufacturer, manufacturing, transport to site, and construction; Use phase emissions (B1 to B5) including use, maintenance, repair, replacement, and refurbishment; and end of life (C1 to C4) including deconstruction, transport to end of life facilities, processing, and disposal.

To estimate the embodied carbon reduction potential of our mass timber prototype, a comparative LCA (A1-A3) has been performed for a 22'x134' structural bay using the LCA tool, One Click LCA. Considering this is a hypothetical project/site, emissions from various LCA stages like the process, use, and waste transport are unknown and have not been included in the analysis. In addition, the emissions for waste processing are less than 4% in the hybrid and mass timber options and are not included given the minimal impact in numbers. Our research compares the structural bay with the baseline concrete, steel, and hybrid options as illustrated in this report. For this comparison, the scope is limited to the structural bay. Elements beyond the scope of a single bay, such as foundations, are not included.

The building life expectancy is assumed to be 60 years. To simplify the accounting of biogenic carbon, it is shown as additional information. This means that neither the negative emissions of storing the CO<sub>2</sub> from the atmosphere nor the release of it is included in Global Warming Potential (GWP) results. Graph (A) on the right visually compares the embodied carbon impact across all the structural options. The output of the analysis

demonstrates that concrete has higher levels of embodied carbon than all the other structures. The baseline steel and the hybrid system result (excluding biogenic carbon) are nearly the same but exceed the mass timber alternatives by almost 40%. The mass timber building outperforms the concrete baseline by approximately 70%.

Our mass timber prototype proved to have reduced emissions when compared with the typical long span mass timber designs, while maintaining consistent performance and vibration criterion. The sequestered CO<sub>2</sub> value for the hybrid option is 22 kg CO<sub>2</sub>e/sqm, while in the mass timber alternatives, the values were around 230 kg CO<sub>2</sub>e/sqm. This indicates an opportunity for long-term carbon storage if the structures are built with consideration for the disassembly and reuse of elements (for instance, using mechanical connections) of the structure at the building's end-of-life. To ensure that the harvesting activities for timber in the forests do not reduce its natural carbon stores, mass timber products shall be sourced from sustainably managed forests with certifications, such as from the Forest Stewardship Council.

### GLOBAL WARMING A1-A3 MATERIALS

Material	kg CO <sub>2</sub> e	CO <sub>2</sub> eq/sqm (kg)
Baseline Concrete	53,610.19	195.75
Baseline Steel	37,689.39	137.62
Hybrid Option	37,454.49	136.76
Typical Mass Timber Long Span	18,353.52	67.02
DES Mass Timber Option	16,723.54	61.06

### BIOGENIC CARBON

Material	kg CO <sub>2</sub> e bio	CO <sub>2</sub> eq/sqm (kg)
Baseline Concrete	0.00	0.00
Baseline Steel	0.00	0.00
Hybrid Option	38,157.63	-21.85
Typical Mass Timber Long Span	75,551.02	-226.53
DES Mass Timber Option	69,965.70	-229.77

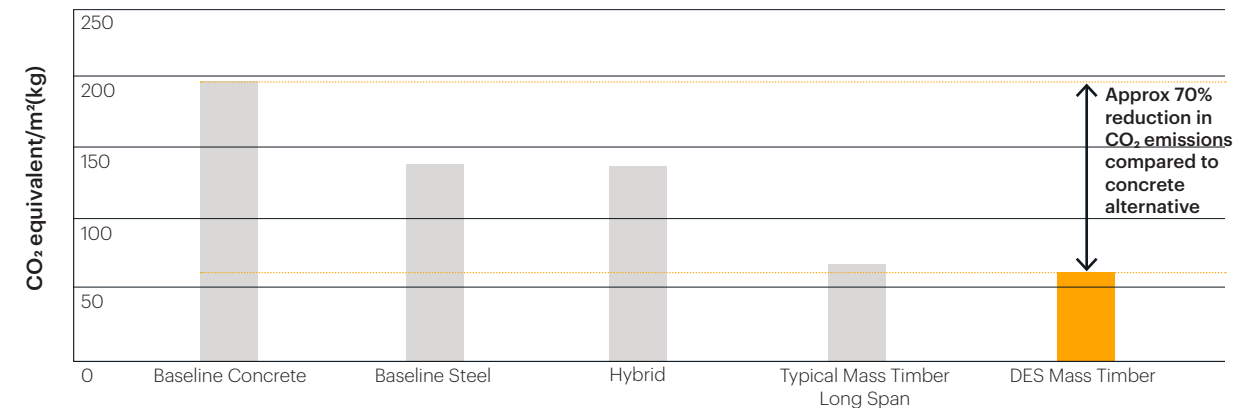

(A) CO<sub>2</sub> Emissions (A1-A3) from all Structural Alternatives

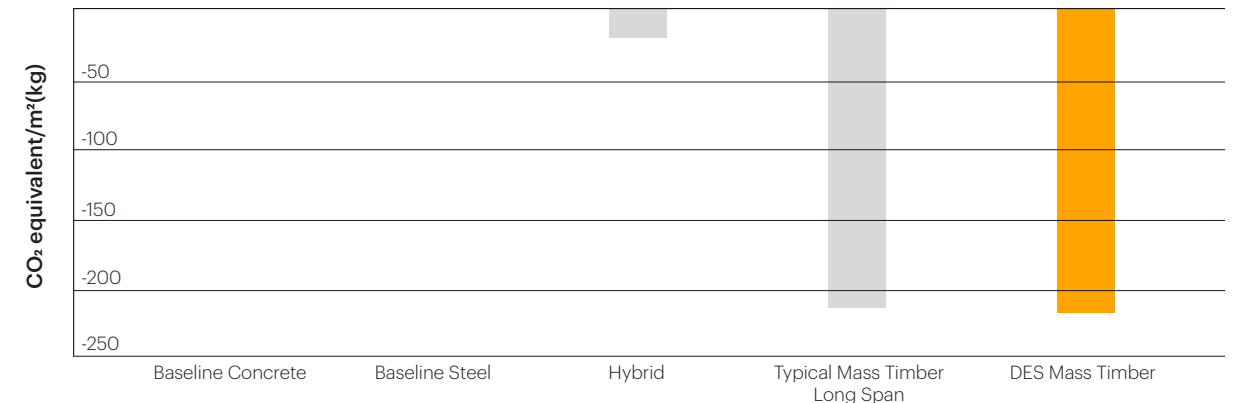

(B) Biogenic Carbon - Capture and Sequestration



# Prototypical Life Science Building

From single structural bay to whole building design



# Prototypical Life Science Building

## STRUCTURAL CONCEPT

To maximize the strength and stiffness of a beam, it is most effective to concentrate the material in top and bottom flanges, as in a steel wide flange beam or truss. For our mass timber concept, we explored assembling CLT panels to create a deep I-section, creating a very stiff section while minimizing material use.

Bending stresses are primarily resisted by compression and tension in CLT panels that make up the top and bottom flanges. The web also consists of CLT panels, however, the majority of the web shear is resisted by steel rods that are tied to the top and bottom panels with bearing plates. These rods are completely encased by the CLT panels, protecting them from fire damage. The web members would also be glued and fastened to the top and bottom flanges to ensure that the beam behaves as a solid unit.

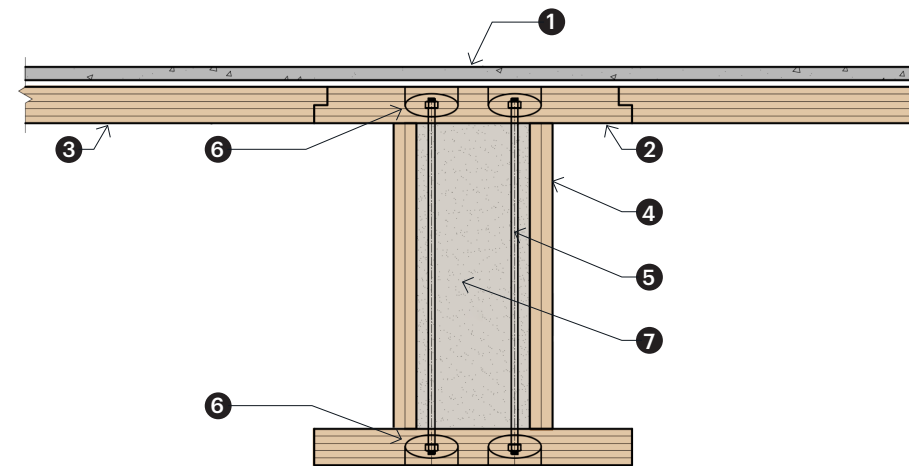

Section through floor beam

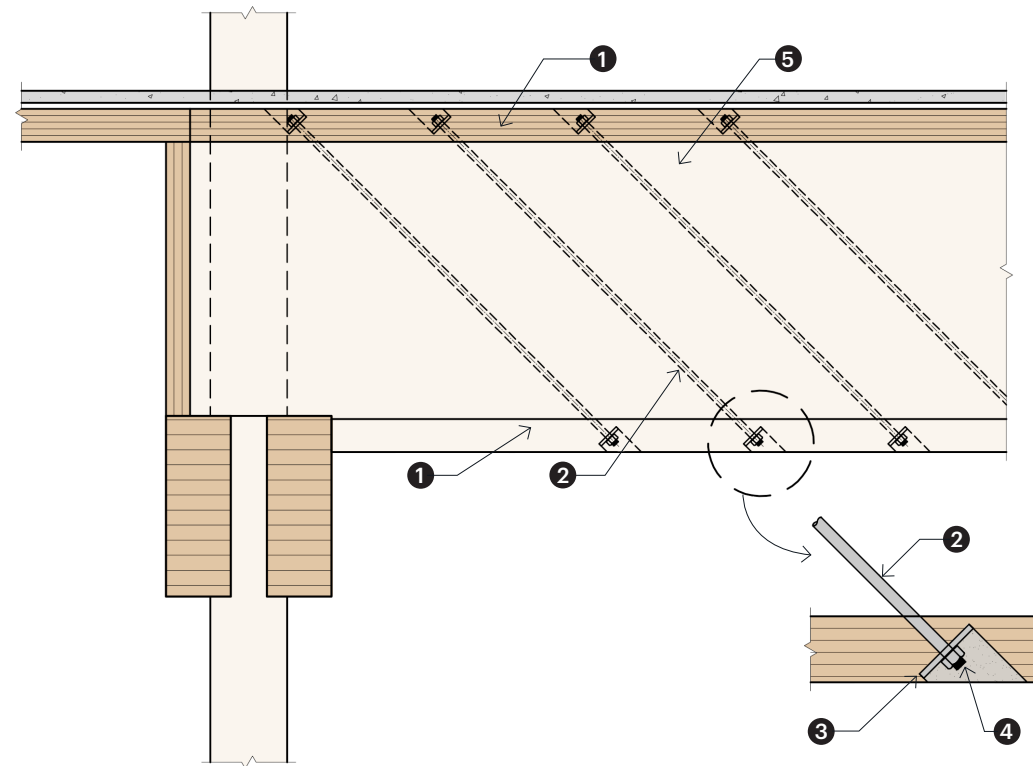

Elevation of floor beam

### Section

- 1 Topping slab + sound insulation
- 2 CLT top + bottom flange
- 3 CLT fill panel
- 4 CLT web panel
- 5 Diagonal tension rod
- 6 Bearing plate
- 7 Fill material

### Elevation

- 1 CLT top + bottom flange
- 2 Diagonal tension rod
- 3 Bearing plate recessed into CLT
- 4 Fireproofing
- 5 CLT web panel

We anticipate that these beams will be assembled on the ground. Once the CLT panels are glued and fastened together, the tension rods can be inserted and tightened, and the beam can be lifted into place. The beam cavity can then be filled with foam or another suitable material to prevent flame spread.

# Prototypical Life Science Building

We have modified the center bay for our mass timber concept. Instead of spanning the 44' center bay with beams, we are taking advantage of the ability of CLT panels to serve as bearing walls, as well as their ability to span in both directions. By utilizing the permanent core elements (stairwells, duct shafts, etc.) for support, it is possible to create a circulation zone for ductwork that utilizes nearly the entire depth of the interstitial space. The girders at the main interior column lines are dropped, allowing secondary distribution ducts to pass over them into the space between the beams. Additionally, openings in the beam webs can be provided to allow for flexible circulation of pipes, conduits, and other utilities. All of this allows for a much shallower overall floor section and floor to floor heights that are the same or less than comparable steel and concrete systems.

We have also utilized CLT panels as exterior bearing walls, which encroach less on the interior space and allow for many exterior skin options.



Building Section

# Prototypical Life Science Building

The proposed mass timber floor system is exceptionally stiff. With a calculated frequency of more than 8 Hertz, our analysis gives an estimated vibration performance of 3600 mips. Even with uncertainties associated with the analysis method, it is clear that this system can provide a vibration environment of 8000 mips or less, similar to our baseline models.

Compared to conventional mass timber construction with similar bay sizes, we find that this system moderately reduces material use, but more significantly, provides a much stiffer floor, and better integration with mechanical distribution systems, allowing for lower floor to floor heights.

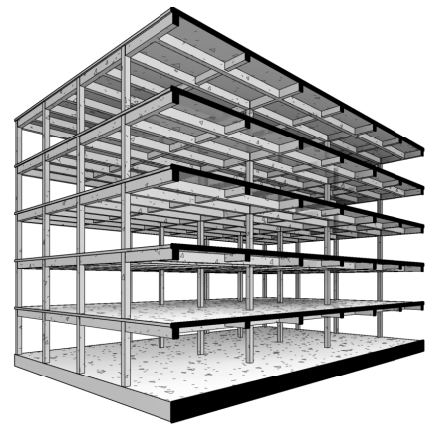

## CONCRETE

Normal wt. concrete topping	3264 cu. ft
Steel reinforcement	8.0 tons

Estimated vibration	7680 mips
Vibration analysis method	CCIP-016



## STEEL

Lightweight concrete topping	1045 cu. ft
Steel deck	3.7 tons
Structural steel	15.3 tons
Steel reinforcement	1.1 tons

Estimated vibration	7603 mips
Vibration analysis method	AISC DG11 2nd Ed., simplified



## HYBRID STEEL/CLT

Normal wt. concrete topping	491 cu. ft
CLT deck	1695 cu. ft
Structural steel	17.8 tons

Estimated vibration	7787 mips
Vibration analysis method	AISC DG11 1st Ed., Chapter 6

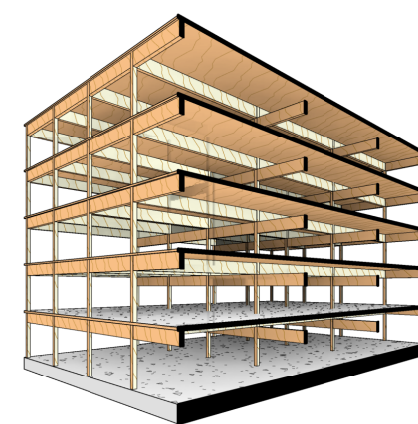

## MASS TIMBER

Normal wt. concrete topping	491 cu. ft
Timber framing	3356 cu. ft

Estimated vibration	7761 mips
Vibration analysis method	AISC DG11 1st Ed., Chapter 6

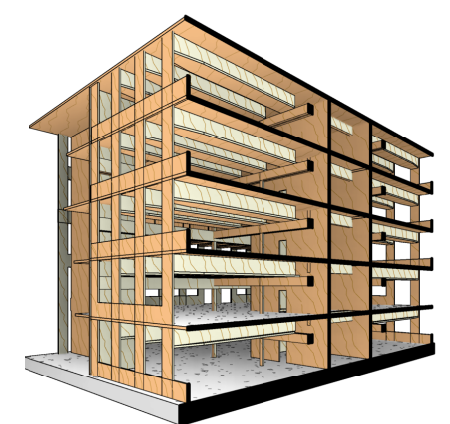

## PROPOSED MASS TIMBER

Normal wt. concrete topping	491 cu. ft
Timber framing	3108 cu. ft

Estimated vibration	3635 mips
Vibration analysis method	AISC DG11 1st Ed., Chapter 6

# Prototypical Life Science Building

## BUILDING PROGRAM

The next step is applying this structural concept to the design of a prototypical life science building. We have looked at our most recent life science building projects and determined the following ideal parameters for a mid-height lab building.

**+ 5-story building @ 175,000 sf total**

**+ 35,000 sf typical floor plate**

**+ 16' floor-to-floor heights**

**+ Centralized building core + offset exit stairs**

**+ Exterior balconies and decks**

## CODE ANALYSIS

Recent changes in International Building Code (IBC 2021) and California Building Code (CBC 2019) allow for taller and larger mass timber structure construction and for the “wood” interior to be fully or partially exposed, depending on the construction type.

The prototypical building design complies with the current 2022 California Building Code as follows:

- + Occupancy Classification: Principal use is Business Occupancy – Group B
- + Minimum Construction Types & Sizes Required: Type IV-C or HT Construction types based on CBC Table 601.
- + Control areas will be constructed within the building where quantities of hazardous materials do not exceed the maximum quantities allowed for storage, dispensing, use and handling. The design and number of control areas are based on CBC Table 414.2.2. The maximum allowable quantity of hazardous materials per control area is based on CBC Tables 307.7(1) and 307.7(2).

With respect to the California Building Code, the number of control areas and maximum quantities of chemical storage and usage allowed become limited on the upper floors of the building. Control areas will be constructed and separated from each other by not less than a 2-HR fire rated horizontal assembly and a 1-HR fire rated wall barrier based on CBC 703.2. CLT panels would need to be analyzed assuming an appropriate char depth based on the timber National Design Specification (NDS). Testing indicates that CLT floors provide up to a 3-HR rating, however, this has yet to be codified into approved assemblies.

## CONSTRUCTION TYPE (ALL SPRINKLERED VALUES)

Type	IV-A	IV-B	IV-C	IV-HT	III-A	III-B	V-A	V-B
<b>Occupancies</b>	Allowable Building Height above Grade Plane, Feet (CBC Table 504.3)							
<b>A, B, R</b>	270	180	85	85	85	75	70	60
<b>L</b>	120	90	85	65	65	55	50	40
	Allowable Number of Stories above Grade Plane (CBC Table 505.4)							
<b>A-2, A-3, A-4</b>	18	12	6	4	4	3	3	2
<b>B</b>	18	12	9	6	6	4	4	3
<b>R-2</b>	18	12	8	5	5	5	4	3
<b>L</b>	8	6	5	5	5	3	3	2
	Allowable Area Factor (At) for SM <sup>1</sup> , Feet <sup>2</sup> (CBC Table 506.2)							
<b>A-2, A-3, A-4</b>	135,000	90,000	56,250	45,000	42,000	28,500	34,500	18,000
<b>B</b>	324,000	216,000	135,000	108,000	85,500	57,000	54,000	27,000
<b>R-2</b>	184,500	123,000	76,875	61,500	72,000	48,000	36,000	21,000
<b>L</b>	60,000	37,500	36,000	36,000	28,500	17,500	18,000	6,500

Allowable building area and height (adapted from CBC Tables 504.3, 504.4, and 506.2)\*

<sup>1</sup>SM = Buildings two or more stories above grade plane equipped throughout with an automatic sprinkler system installed in accordance with Section 903.3.11

\*Source - “Early Design Decisions: Priming Mass Timber Projects for Success”, presentation by Chelsea Drenick and Mike Romanowski, WoodWorks March 16, 2022

A Group L Occupancy laboratory suite concept, which may include multiple laboratories, offices, storage, and equipment rooms or similar support functions, could be used where the aggregate quantities of hazardous materials stored and used do not exceed the quantities outlined in CBC Table 453.7.2.1. High-Hazard Group H Occupancy (H2 or H3) would be restricted to the ground floor of the building or a separate structure on site.

# Prototypical Life Science Building

## BUILDING MASSING AND EXTERIOR

To illustrate the flexibility and full potential of our mass timber structure concept, we opted for a simple monolithic building massing. Our design approach maximizes both the usable floor area—key for developer projects—and the inherent structural performance of the prototype mass timber I-beam configurations.

We chose not to consider special design conditions that would require extensive tweaking to the typical mass timber I-beam modules, and hence, minimize add-on structural support elements. An example is the recessed balcony, which would entail lowering the steel deck and using shallower beams if using steel construction.

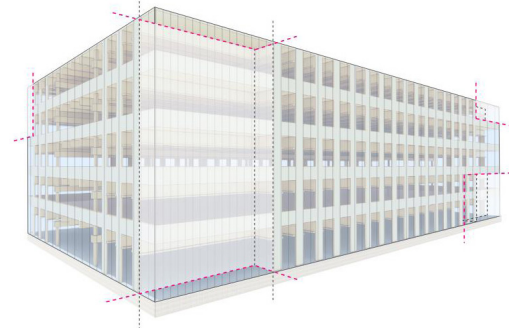
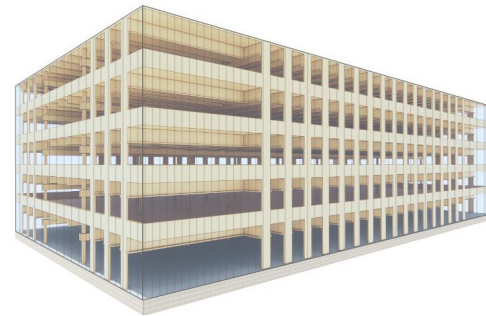

For this building, we took advantage of the rotated I-beam modules at the building ends and incrementally cut back the 11-foot structural bays to create outdoor decks on upper floors and a double-height entry lobby. The architectural articulation is further reinforced by the ability of the CLT decks to project 5 feet from the main beams and alternates the placement of glass walls and railings.

Our design approach embraces the integrity of the mass timber structure and reduces supplementary structural elements that would otherwise increase material quantities, construction costs, and embodied carbon.



Building cross-section showing incremental adjustment of structural bays and placement of glass walls to create outdoor decks and double-height lobby

# Prototypical Life Science Building

## Expressing the depth and beauty of the wood material from inside to outside

The basic building massing is an honest expression of the mass timber structure, in the sense that it is an “extruded volume” out of the repetitive CLT beams and exterior bearing wall arrangement. Our team explored a variety of methods to reveal the depth and beauty of the wood material from inside to outside.

In this demonstrative design, the bulk of the building facades are exposed CLT bearing walls clad with natural wood laminate, with edge returns that emphasize the vertical gravity forces and function of the wall panels. This monolithic expression is organically eroded into stepping glass curtain walls that act as a veil, screening and revealing the wall panels as interior elements. Gradually, the glass walls converge to special moments at the building corners and transform into cascading outdoor decks or glass-clad boxes celebrating the vertical circulation.

The building façade is further animated by fluid horizontal edges that are natural extensions of the CLT panels at different floor levels and embrace the slightly projected bay windows. All these treatments are designed to work within the inherent loading capacity of our mass timber structure concept. The result is an appealing life science building architecture with multiple dimensions and an expressive mass timber concept.



Multifaceted treatment of CLT bearing wall-based massing

# Prototypical Life Science Building

It is important to highlight the varied façade treatment as a dynamic response to the outside environment, taking into account factors such as solar access and views.

## North façade

Projected bay windows are supported by extended CLT floor panels. The full-height glass wall façade brings in more daylight to the interior and contrasts with the controlled window openings between the CLT bearing walls.

## South and west façades

Maximizing daylighting potential while blocking unwanted heat and glare were key design factors for these orientations. We introduced horizontal sunshades and light shelves for passive solar control. Window openings are carefully optimized to reduce heat gain.

## Balconies

Varied glass wall placement creates a layering effect of outdoor decks and bay windows offering solar protection and views to the outside



North Façade



South and West Façades



Balconies



# Prototypical Life Science Building



# Prototypical Life Science Building

## Typical life science floors



Conceptual test-fit plan of a typical floor, showing 50/50 split between open office and lab spaces

The prototypical life science building has a 35,000-sf floor plate, which is ideal for growing life science companies looking for larger lab spaces. The 22 x 44 foot structural bay is built on the common industry practice of the 11-foot lab bench module. In this case, the modules are efficiently arranged along both the long sides and short ends of the building.

With a centrally located building core and assumed 8-foot circulation corridors, the proposed floor has a 44-foot deep open usable space on all four sides. This is comparable to long-span steel construction and offers significant flexibility for lab and office space planning.

The exterior CLT panels are spaced at 11 feet on center, and work cohesively with both the 22-foot mass timber structural bays and the lab bench layout. As shown in the conceptual test fit plan, the lab benches align with the solid wall panels and allow the window openings to directly face the circulation and work areas.

With the taller openings built into the base structure, more daylight, whether direct from outside or reflected from the light shelves, will be able to project into the interior, greatly enhancing the experience of the occupants.

# Prototypical Life Science Building

The mass timber life science building is designed for either CBC Type IV-C or HT Construction types. With no or reduced (1-HR) fire resistance rating required for interior non-bearing walls, partitions and elements, there is an opportunity to expose and express the mass timber beams and wall panels as interior finishes, whenever applicable for lab and office spaces.

From a sustainability perspective, this will substantially reduce the amount of additional interior finishes and materials, with the natural warmth of the wood material as a welcoming biophilic feature for the occupants.

## FIRE-RESISTANCE RATING REQUIREMENTS FOR BUILDING ELEMENTS

Building Element	Type III		Type IV			
	A	B	A	B	C	HT
Primary structural frame (see Section 202)	1	0	3	2	2	HT
Bearing walls						
Exterior	2	2	3	2	2	2
Interior	1	0	3	2	2	1/HT
Nonbearing walls + partitions			See Table 705.5			
Exterior						
Interior	0	0	0	0	0	See Sect. 2304.11.2
Floor construction + associated secondary structural members (see Section 202)	1	0	2	2	2	HT
Roof construction + associated secondary structural members (see Section 202)	1	0	1	1	1	HT

Fire-resistance rating requirements (adapted from CBC Table 601)

The building section drawing illustrates the typical core/corridor and laboratory or office space arrangement on different floors. A 16-foot floor-to-floor height is used for this building, which allows for an 11-foot headroom clearance under the mass timber beam. The varied façade treatment described earlier corresponds to different potential interior uses and brings in the desired amount of natural daylight.



Enlarged building section of a typical wing

# Prototypical Life Science Building

## BUILDING AND MEP INTEGRATION

Life science facilities conceived using modular planning principles provide a basis for flexibility and adaptability during design, construction, and through occupancy of the facility into the future. The planning module serves as the organizing basis for building structure, walls, and partitions, as well as the distribution of building ventilation, utilities, and services. This approach ensures a building design that allows for future modifications, minimizing the impact on the building infrastructure, and a rationale for planning decisions.

The planning module is the basis for small instrumentation-based or special use laboratories (lab support spaces) and can be combined for larger open lab environments. It comprises the bench area as a workplace for procedures, protocols, instrumentation, equipment, and workstations, with the aisle space in front of the bench allowing for movement: wall benches and islands or peninsula benches of 30 inches and 60 inches depth, respectively, along with 60 inch aisles for circulation and equipment or material movement.

We have integrated the organized layout and distribution of mechanical ductwork, electrical, and lab plumbing, and piped services into the planning module. The planning concept of laboratory modularity offers greater predictability and reliability in the organization and location of horizontal and vertical utility distribution systems.

## FLEXIBILITY, EXPANDABILITY, AND SAFETY

The prototypical mass timber structure allows for the flexibility and expansion of the labs, which is based on a 22-foot repetitive structural module and modular utility distribution system. The labs can expand as needed, without disrupting function or adjacent laboratories. Each laboratory will provide sufficient area and the appropriate linear feet of space for casework, fume hoods, and open floor space for equipment and storage. Individual laboratories will have independent access and control of their respective utilities to allow for reconfiguration without affecting adjacent laboratories.

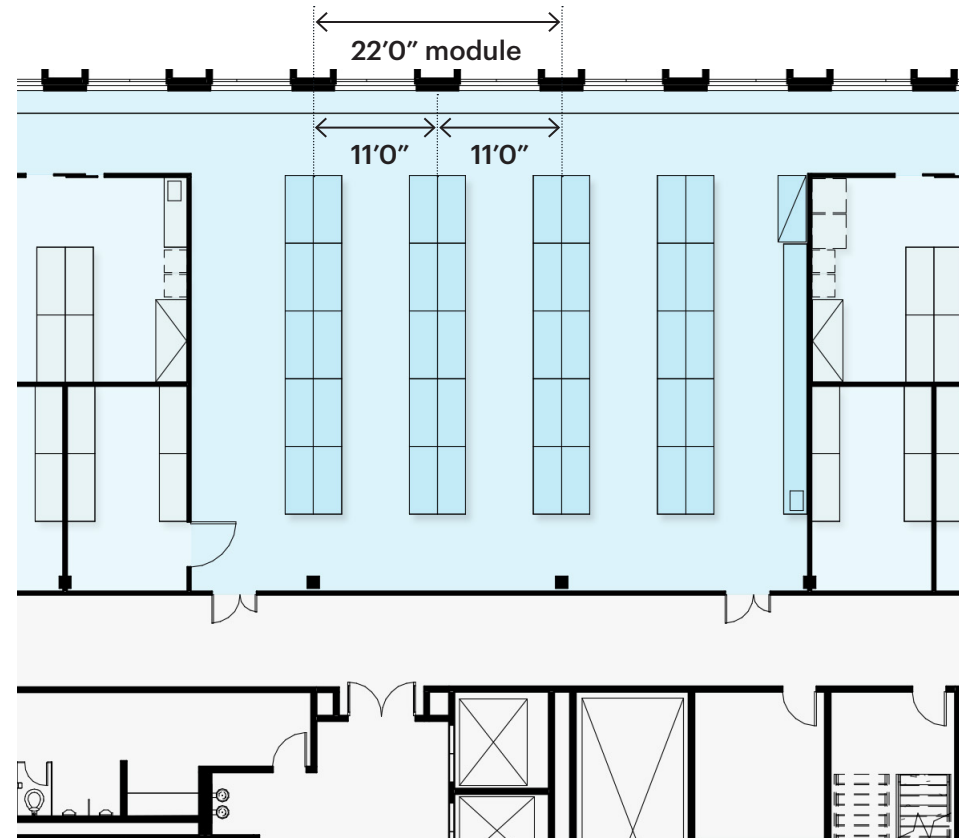

In this hypothetical test fit layout, the laboratory units will provide for efficient utilization of zones designated for fume hoods, casework, equipment, and storage without wasting floor or wall area. Economy can be gained by clustering laboratory units together.

Higher hazard activities are to occur in a zone at the back of the lab with lesser hazard activities occurring at the front. Fume hoods with under counter acid storage cabinets, flammable storage cabinets, and cylinder tanks for specialty gasses will be located in the high hazard zone.



# Prototypical Life Science Building

## VERTICAL INTEGRATION

Vertically, laboratory modular planning organizes the horizontal stacking of the building structure and systems.

Within the 16-foot floor-to-floor height, the space is zoned for activities to occur. The first 7 feet of vertical space is where workstations, modular lab benches with upright shelving, benchtop instrumentation, or floor mounted equipment can occur along the 11-foot planning module. At 10 feet, lighting and piped services are organized for either an open ceiling or suspended ceiling depending on research activities happening below.

Piped lab utilities, power, and data are distributed horizontally through openings in the mass timber beams to ceiling service panels (CSPs) located on a modular basis to benches, instrumentation, and equipment.



Ceiling service panels (CSPs) located on a modular basis to benches

In open ceiling labs where Biosafety Level 1 (BSL1) research activities occur, CSPs are incorporated into an overhead service carrier or “cloud” ceiling suspended below the mass timber beam. Between the beams, the tall open space allows for the distribution of supply and exhaust ductwork from mains in the corridor, minimizing crossovers. Alternatively, a matching decorative ceiling can be installed between the CLT beams.

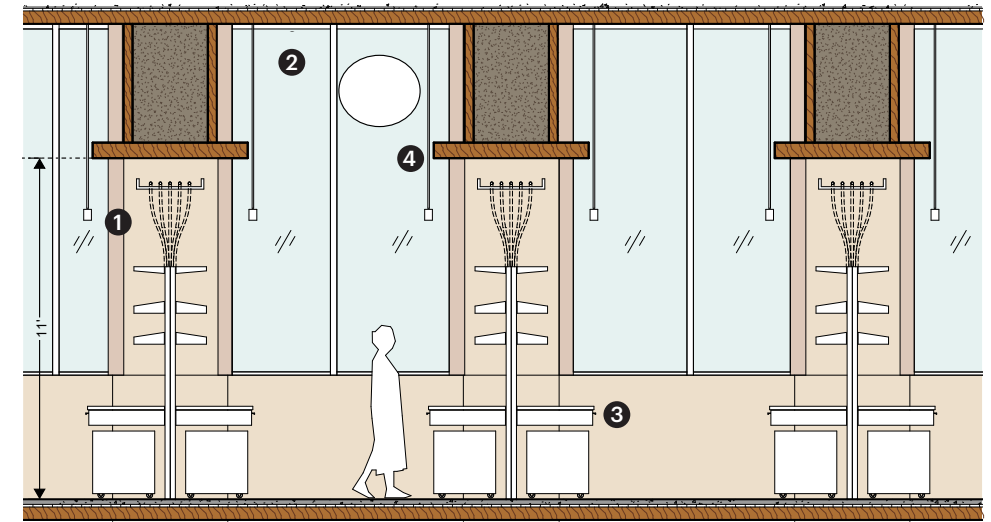

BSL 1 Open Lab Area - Exposed Wood Soffit

- 1 Ceiling cloud with CSPs
- 2 Exposed CLT beams and panels
- 3 Typical lab benches
- 4 CLT web panel

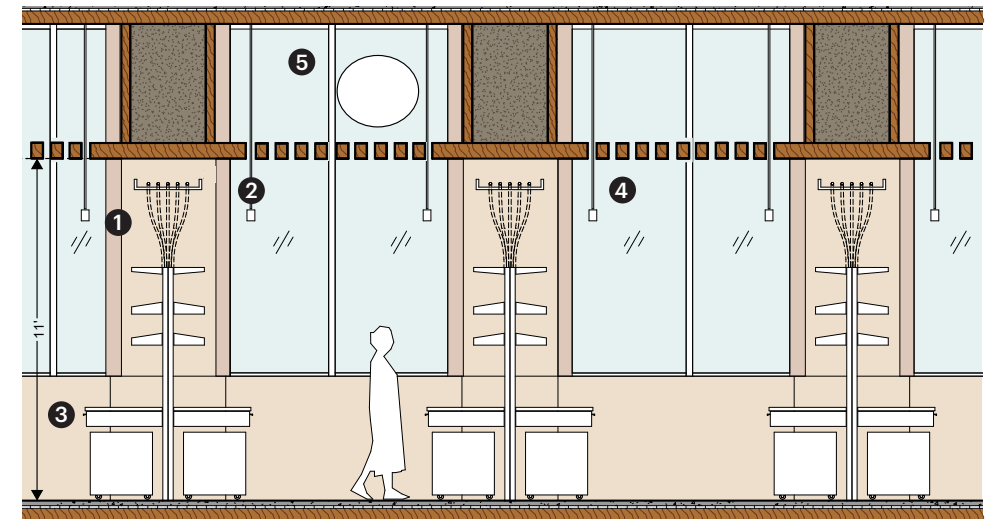

BSL 1 Open Lab Area - Wood Slats or Solid Ceiling Panels

- 1 Ceiling cloud with CSPs
- 2 Exposed CLT beams and panels
- 3 Typical lab benches
- 4 Decorative ceiling - wood slats or solid panels
- 5 HVAC ductwork

# Prototypical Life Science Building

## VERTICAL INTEGRATION

In enclosed labs, where Biosafety Level 2 (BSL2) or higher research activities occur, or lab support and control areas, gypsum ceiling can be installed below the CLT beams while maintaining a 10-foot headroom clearance.

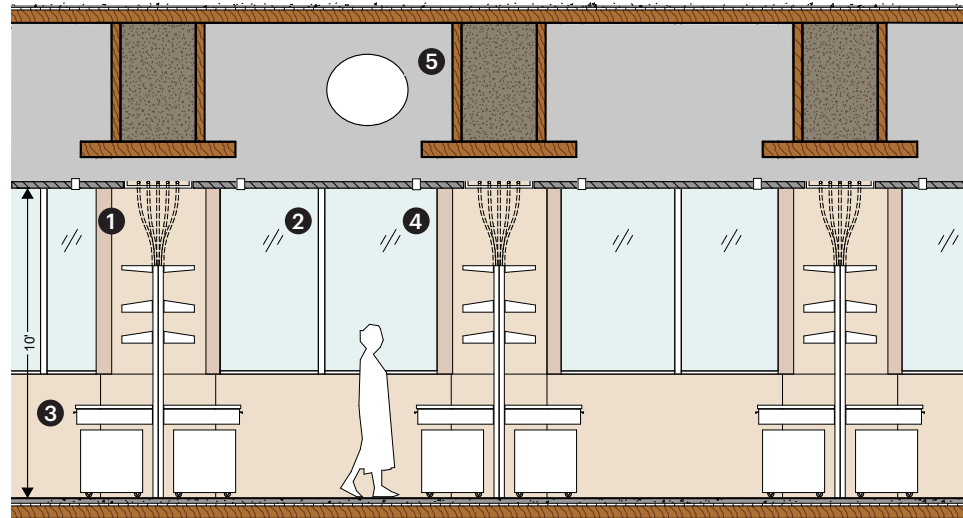

BSL 2 or Higher - Enclosed Lab and Support Area

- 1 Ceiling cloud with CSPs integrated into ceiling system
- 2 Gypsum ceiling panels
- 3 Typical lab benches
- 4 Recessed light fixtures
- 5 HVAC ductwork

The section below illustrates how fume hoods are connected to the exhaust duct in a typical lab.

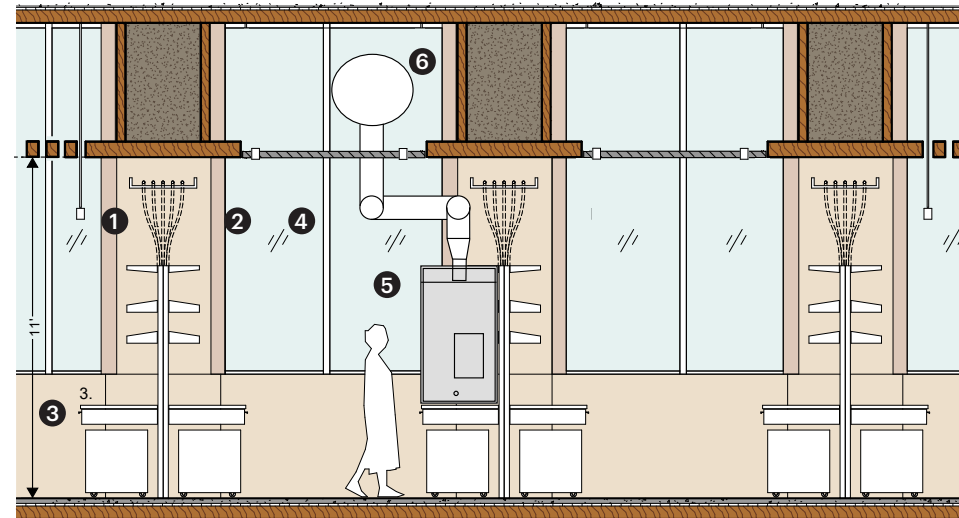

Lab Area with Fume Hoods

- 1 Ceiling cloud with CSPs
- 2 Exposed CLT beams and panels
- 3 Typical lab benches
- 4 Decorative ceiling - wood slats or solid panels
- 5 Fume hoods
- 6 Exhaust ductwork

# Prototypical Life Science Building

## SUSTAINABILITY



### MASS TIMBER + BIOPHILIC EXPERIENCE

Over the last couple of decades, considerable research and studies have corroborated that adding elements of nature to living spaces can induce benefits such as positive changes in cognition and emotion, and in turn, impact stress levels, health, and well-being. These benefits are often referred to as biophilic responses.

Per the research done by Terrapin Green, the presence of wood in our built environment supports a biophilic experience, creating more restorative and convivial spaces for all.

### MINIMIZING FINISH MATERIALS

To optimize the benefits of wood and encourage a biophilic response, it is best to leave it exposed in the most visible spaces, such as ceilings, walls, or high-touch surfaces like railings and door pulls. Leaving the structural system exposed leads to a reduction in interior finishing costs and embodied carbon from interior finishes.

Interior finishes can be a notable source of toxic and hazardous emissions within the built environment. Because interiors are often replaced multiple times over the life of a typical 60-year building, their cumulative impacts can compound and exceed those of the base building. For instance, carpet is a high impact material, and one of our internal studies looking at the impact from carpets shows that the emissions from carpet alone over the entire life cycle of a project can equal the CO<sub>2</sub> emissions of a mass timber structural bay shown in the embodied carbon section of this report.

This evaluation does not include all carpet options and there can be a fivefold difference in the Global Warming Potential of carpet alternatives available. Eliminating or greatly limiting the use of carpet and other interior finish materials can lead to a significant reduction in the overall embodied carbon of a building.

# Prototypical Life Science Building

Baseline Steel/Concrete with External Overhang

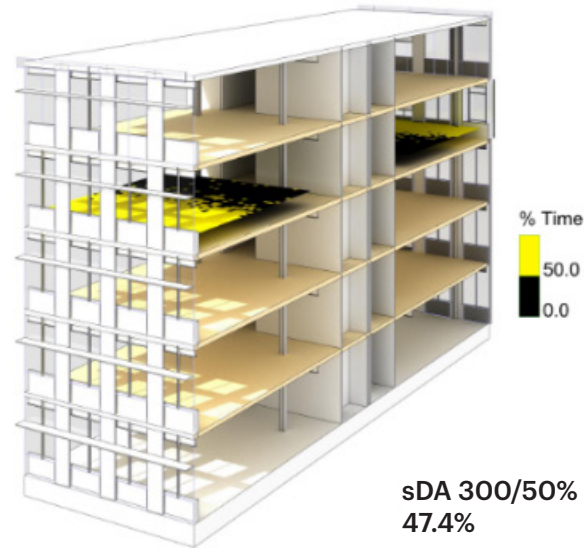

DES's Mass Timber with External Overhang

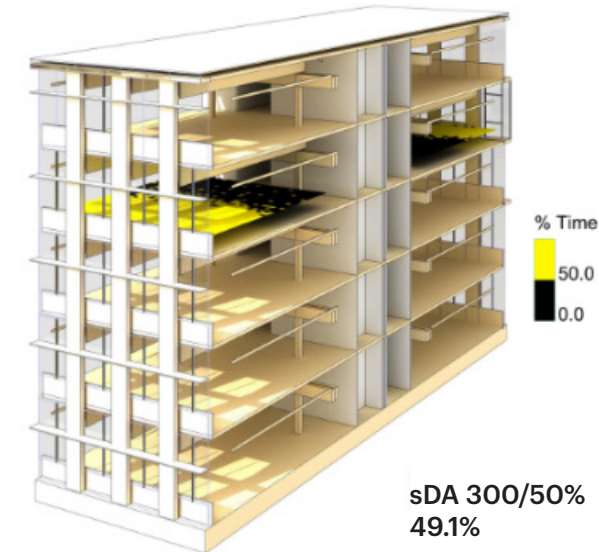

DES's Mass Timber with External Overhang and Internal Light Shelf

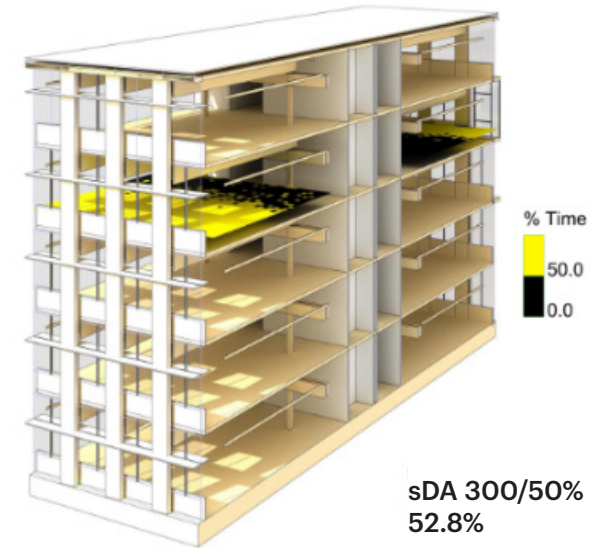

## ACCESS TO NATURAL DAYLIGHT

Research in the last couple of decades has consistently proven that good daylighting and access to views enhance our circadian rhythms and help improve productivity, overall health, and well-being. Our mass timber prototype eliminates the perimeter beam and provides opportunities to add higher window openings.

As shown in the daylighting studies, the Spatial Daylight Autonomy (sDA) within the space increases with this option. Higher sDA values indicate that a larger interior space receives at least 300 lux of daylight for at least 50 percent of the workday. Further daylighting enhancement and glare control devices like light shelves can provide opportunities to direct natural light deeper into the floor space, while also controlling the amount of annual sunlight exposure.

Annual Sunlight Exposure (ASE) refers to the percentage of space that receives too much direct sunlight (1000 lux or more for at least 250 occupied hours per year) and is under 10% for the option with the light shelves.

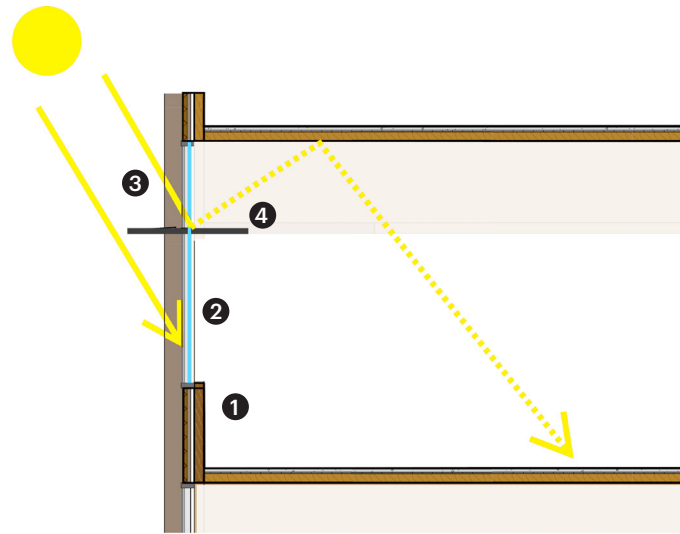

Light shelf concept (illustrative, summer solstice)

- 1 30" sill height CLT panels / exterior wall
- 2 Typical window openings (between beams) - 30" from finish floor to bottom of CLT panels
- 3 Exterior sunshade blocks unwanted daylight
- 4 Interior light shelf (aligns with bottom flange of CLT beam)



# Conclusion

## Exciting opportunities

**Our research demonstrates that carbon can be reduced in life science buildings through thoughtful re-imagining of the structural system.**

The new CLT assembly design can yield appropriate floor-to-floor heights, adequate vibration, and open, flexible floor plates. The system can work with laboratory benches and equipment, mechanical and electrical distribution systems, and other life science program requirements.

The resulting building design can be innovative and dynamic, with inspiring interiors. The new system can be more efficient and have better performance than traditional steel and concrete structures.

### CHALLENGES

Mass timber can be a competitive and sustainable option for life science buildings. However, to optimize material use and cost, a significant re-thinking of conventional post and beam systems is recommended and perhaps required. Further advancements can be made with the careful integration of building core and mechanical systems. While we believe our project illustrates realistic opportunities and encourages consideration for the use of mass timber in life science buildings, it has also illuminated several hurdles to overcome.

The development of simplified procedures for estimating the vibration performance of timber floor systems would greatly help evaluate timber options in the early phases of a project. Preferably, assumptions and results would correlate with procedures used for steel and other systems, so that expected performance can be directly compared. While there are detailed procedures for assessing vibration in timber floors, they can be challenging to employ in the initial design stages. Currently, it would be very difficult for a typical practicing engineer to give assurance to an owner that a timber option will truly provide performance equivalent to a steel or concrete structure.

The timber I-beam concept is supported by basic structural calculations, but more detailed finite element modeling is needed to further validate its expected performance. The next steps would also include vetting with builders to verify its constructability and determine potential cost benefits.

### GOING BEYOND THE RESEARCH

Though our research did not consider lateral force resisting systems, we see opportunities for researching systems that utilize CLT panels to provide greater resiliency. Currently, CLT panel shear wall design typically relies on screw connections that deform and lose strength under repeated loading cycles. While this provides for life safety, there could be considerable post-earthquake deformation and required repairs.

Rocking shear wall and post-tensioned frame concepts currently being employed in concrete construction could in principle be adapted to CLT walls. Since these systems rely on elastic stretching of steel rods or strands rather than inelastic deformation of screw connections, they could potentially provide a self-righting system with less expected damage and loss in a major earthquake.

### SUSTAINABILITY

As discussed in previous sections of this report, the reuse of structural timber—whether through the adaptive reuse of an existing structure or through deconstruction and disassembly—presents an opportunity for long-term carbon storage in buildings. Additional research is needed on the topic of adaptive buildings and design for disassembly, including more efficient and effective ways to construct buildings.

Our research, along with other studies, has proved that mass timber construction can have a significant impact on carbon reduction and sequestration in the building industry. Designing our building envelopes for reduced carbon emissions is another key strategy worth studying. Most cladding materials that are used on a concrete or steel structure can be used on a mass timber building as well; however, a key consideration for mass timber buildings is designing an envelope that can be rapidly installed, protecting the wood structure from moisture absorption during construction. Therefore, there is an opportunity for researching low carbon materials and strategies for reduction in the quantity and weight of facade materials that can have an impact on both the cost and embodied carbon reduction of projects.



# Bibliography + Acknowledgements

## Sources/Works Cited

- + AISC Design Guide 11, First Edition Floor Vibrations Due to Human Activity, American Institute of Steel Construction, 1997.
- + AISC Design Guide 11, Second Edition Vibration of Steel-Framed Structural Systems Due to Human Activity, American Institute of Steel Construction, 2016.
- + CCIP-016, A Design Guide for Footfall Induced Vibration of Structures, The Concrete Center, 2007.
- + Comparing Embodied Carbon in Facade Systems, Frances Gannon, Make Architects, 2021.
- + Early Design Decisions: Priming Mass Timber Projects for Success, Chelsea Drenick & Mike Romanowski, WoodWorks - Wood Products Council, 2022.
- + Fire Design of Mass Timber Members - Code Applications, Construction Types and Fire Ratings, Richard McLain & Scott Breneman, WoodWorks - Wood Products Council, 2021.
- + How to Calculate the Wood Carbon Footprint of a building - Expanding the possibilities of wood building design - Edie Sonne Hall, Architectural Record / WoodWorks - Wood Products Council, 2020.
- + Low Carbon Aluminum - Solution for Sustainable Construction and Renovation, White paper, BIONOVA / One Click LCA, 2020.
- + Peter, Ema. 2016. "T3 by MGA and DLR." <https://www.archdaily.com/908942/mass-timber-shattering-the-myth-of-code-exceptions>. 18 Jan 2023.
- + Tall Wood Buildings: Design, Construction and Performance, Michael Green and Jim Taggart, 2020.
- + The Nature of Wood: An Exploration of the Science on Biophilic Responses to Wood, Terrapin Green, 2022.
- + 2022 California Building Code, Title 24, Part 2 (Volumes 1 & 2).
- + U.S Mass Timber Floor Vibration Design Guide, Woodworks, 2021.

## Acknowledgements

### One Workplace

We would like to thank One Workplace for giving us the opportunity to conduct this research through the ONEder Grant. Special thanks to Amy Nieva and Akshat Jain for all their support and guidance throughout this exciting research journey!

---

### DES Graphics + Marketing

**Bernice Kim**

**Blaine Tehaney**

**Chloe Chen**

**Elizabeth Wong**

**Michael Valestrino**

---

**Akshat Jain** Vantis

**Amy Nieva** One Workplace

**Chelsea Drenick, SE** WoodWorks - Wood Products Council

**One Click LCA** (for sponsoring the use of proprietary LCA software)

**Stacey Ames** Open Square

**Steven Lank** Colin Gordon Associates

# Reducing Embodied Carbon in Life Science Buildings through Mass Timber

## ONEder Grant Report

### Research Team

Kenny Hung ✕ Tom Parrish ✕ Reema Nagpal ✕ Amy Doman ✕ Bei Xu ✕ David Hronek



Kenny Hung



Tom Parrish



Reema Nagpal



Amy Doman



Bei Xu



David Hronek

### Advisors

Susan Eschweiler ✕ John Fullerton



Susan Eschweiler



John Fullerton

### Contact

Kenny Hung AIA, LEED AP BD+C, WELL AP, Fitwel  
Senior Associate | Sustainability Lead  
khung@des-ae.com

Tom Parrish SE  
Associate Principal | Director of Structural Engineering  
tparrish@des-ae.com